

# UNISTAR

---

ENERGY SOLUTIONS



# INDOOR LIGHTING - Bulbs A-Type

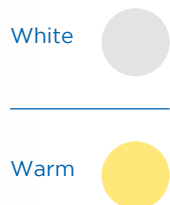

## Dimensions

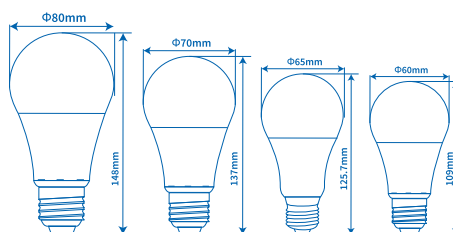

## Models

Models	Power	Voltage Range	Flux	Power Factor (PF)	Cap	Outer Color
A60 Bulb - 9W	9W	175-250V	900 Lm	≥0.5	E27	Milky
A65 Bulb - 12W	12W	175-250V	1200 Lm	≥0.5	E27	Milky
A70 Bulb - 15W	15W	175-250V	1500 Lm	≥0.5	E27	Milky
A80 Bulb - 18W	18W	175-250V	1800 Lm	≥0.5	E27	Milky

## Features & Benefits

Category	Indoor Lighting
Sub-Category	Bulbs
Type	A-Type
Variants	White, Warm, Smart option (only available in 9W)
Warranty	3 Years
Certificates	Proudly Made In Egypt

## A-Type Technical Data

Bulb Material	PC
Housing Material	PC
Color Tempertaure	3000K / 6400K
Frequency	50Hz
Current	<100mA
Luminous Efficiency	100Lm/W
CRI	≥80
Lifetime	25,000h
Life Code	L80 F50
Complies with	ES7823, ES7773, ES7774, IEC62560, IEC62612





# INDOOR LIGHTING - Bulbs G-Type

## Dimensions

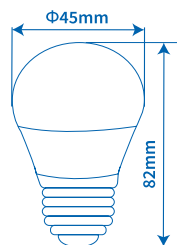
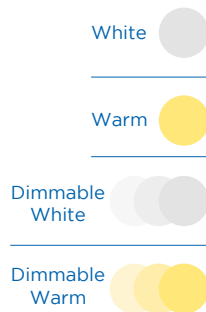

## Models

Models	Power	Voltage Range	Flux	Power Factor (PF)	Cap	Outer Color
G45 Bulb - 5W	5W	175-250V	500 Lm	≥0.5	E14/ E27	Milky

## Features & Benefits

Category	Indoor Lighting
Sub-Category	Bulbs
Type	G-Type
Variants	White, Warm, Available with 3-step dimming option
Warranty	3 Years
Certificates	Proudly Made In Egypt

## G-Type Technical Data

Bulb Material	PC
Housing Material	PC
Color Tempertaure	3000K / 6400K
Frequency	50Hz
Current	<100mA
Luminous Efficiency	100Lm/W
CRI	≥80
Lifetime	25,000h
Life Code	L80 F50
Complies with	ES7823, ES7773, ES7774, IEC62560, IEC62612



# INDOOR LIGHTING - Bulbs C-Type

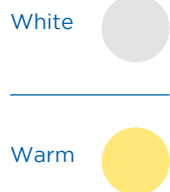
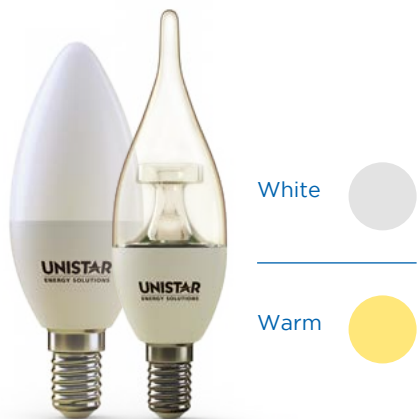

## Dimensions

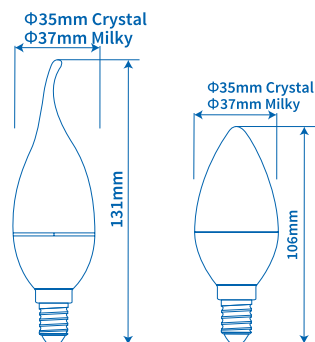

## Models

Models	Power	Voltage Range	Flux	Power Factor (PF)	Cap	Outer Color
Candle Crystal - 6W	6W	175-250V	600 Lm	≥0.5	E14	Crystal
Angular Candle Crystal - 6W	6W	175-250V	600 Lm	≥0.5	E14	Crystal
Candle Milky - 6W	6W	175-250V	600 Lm	≥0.5	E14	Milky
Angular Candle Milky - 6W	6W	175-250V	600 Lm	≥0.5	E14	Milky

## Features & Benefits

Category	Indoor Lighting
Sub-Category	Bulbs
Type	C-Type
Variants	White, Warm, Crystal, Milky, Candle, Candle Angular
Warranty	3 Years
Certificates	Proudly Made In Egypt

## C-Type Technical Data

Bulb Material	PC
Housing Material	PC
Color Tempertaure	3000K / 6400K
Frequency	50Hz
Current	<100mA
Luminous Efficiency	100Lm/W
CRI	≥80
Lifetime	25,000h
Life Code	L80 F50
Complies with	ES7823, ES7773, ES7774, IEC62560, IEC62612

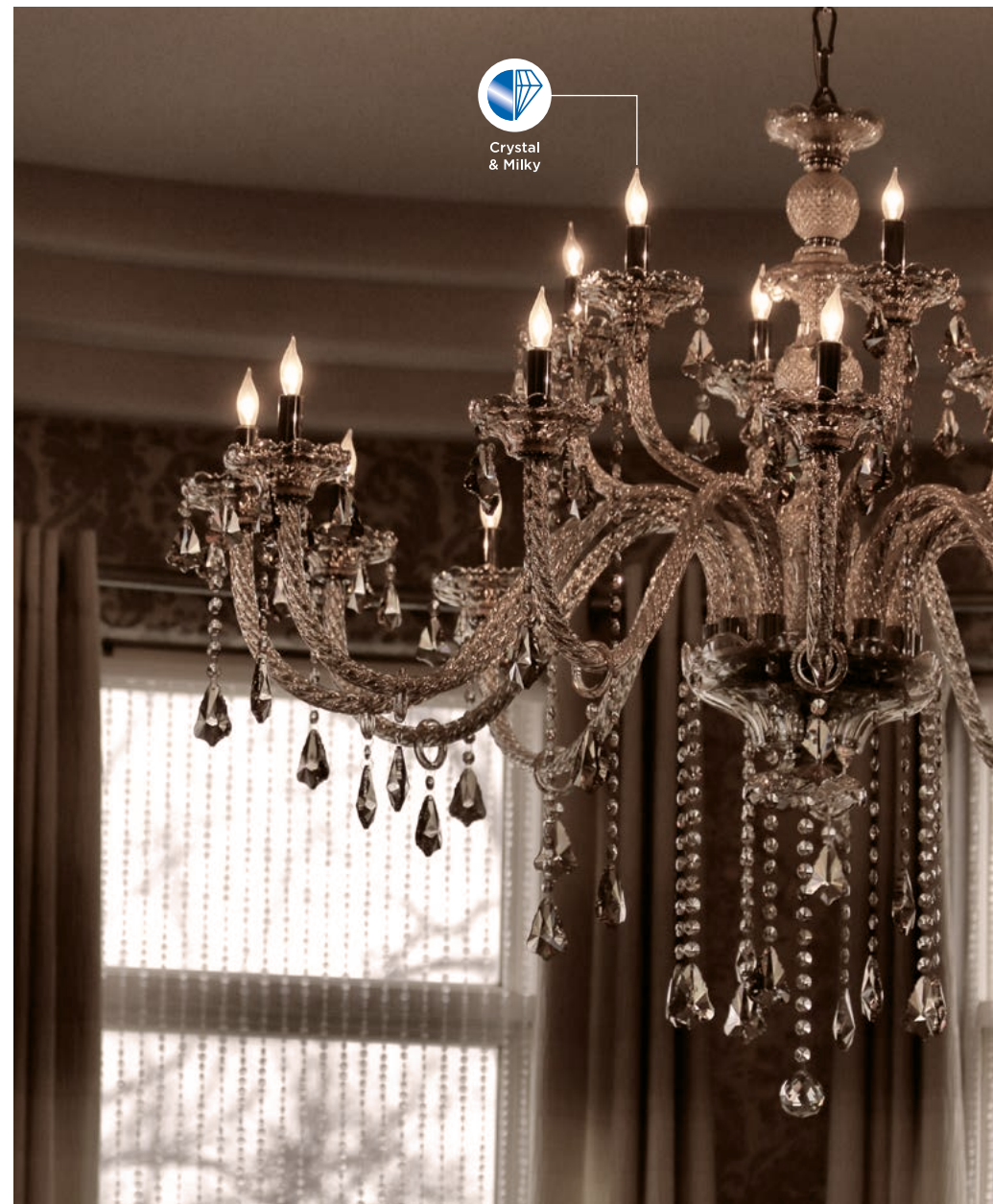

# INDOOR LIGHTING - MR16 Spot Lamps

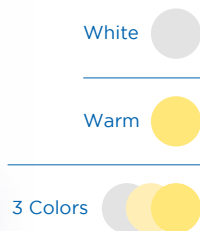

## Dimensions

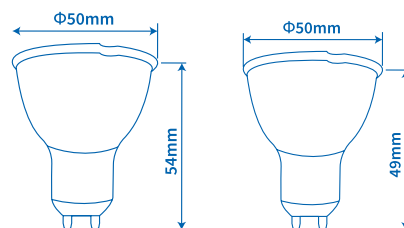

## Models

Models	Power	Voltage Range	Flux	Power Factor (PF)	Cap	Outer Color	Variants
MR16 Spot Lamp Milky - 5W	5W	220-250V	500 Lm	≥0.5	GU5.3	Milky	1-Color
MR16 Spot Lamp 3 Colors - 5W	5W	175-250V	500 Lm	≥0.5	GU5.3	Crystal	3-Colors
MR16 Spot Lamp Crystal - 6W	6W	175-250V	600 Lm	≥0.5	GU5.3	Crystal	1-Color

## Features & Benefits

Category	Indoor Lighting
Sub-Category	Spot Lamps
Type	GU5.3
Variants	White, Warm, 1-Color, 3-Colors
Warranty	3 Years
Certificates	Proudly Made In Egypt

## GU5.3 Spot Lamps Technical Data

Bulb Material	PC
Housing Material	PC
Color Tempertaure	3000K / 6400K
Frequency	50Hz
Current	<100mA
Luminous Efficiency	100Lm/W
CRI	≥80
Lifetime	25,000h
Life Code	L80 F50
Complies with	ES7823, ES7773, ES7774, IEC62560, IEC62612





# INDOOR LIGHTING - GU10 Spot Lamps



White



Warm



## Dimensions

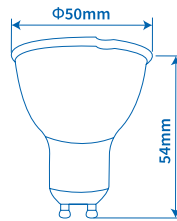

## Models

Models	Power	Voltage Range	Flux	Power Factor (PF)	Cap	Outer Color
GU10 Spot Lamp Crystal - 7W	7W	175-250V	700 Lm	≥0.5	GU10	Crystal

## Features & Benefits

Category	Indoor Lighting
Sub-Category	Spot Lamps
Type	GU10
Variants	White, Warm
Warranty	3 Years
Certificates	Proudly Made In Egypt

## GU10 Spot Lamps Technical Data

Bulb Material	PC
Housing Material	PC
Color Tempertaure	3000K / 6400K
Frequency	50Hz
Current	<100mA
Luminous Efficiency	100Lm/W
CRI	≥80
Lifetime	25,000h
Life Code	L80 F50
Complies with	ES7823, ES7773, ES7774, IEC62560, IEC62612

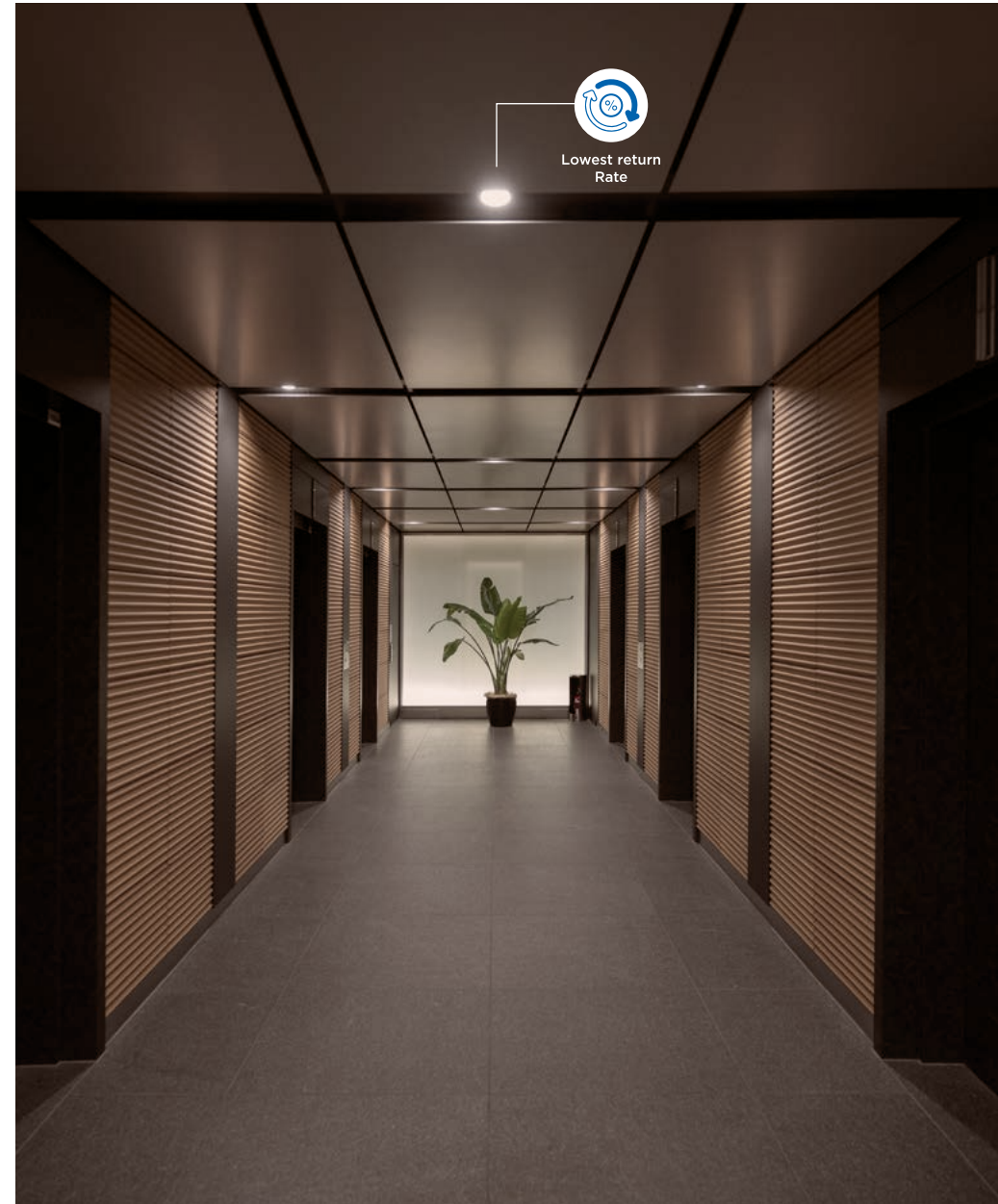

# INDOOR LIGHTING - Tube Lamps



Economic  
GAEB Specs

## Dimensions

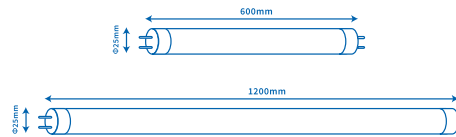

## Models

Models	Power	Voltage Range	Flux	Power Factor (PF)	Cap	Length	Outer Color
T8 Tube Lamp 600mm - 9W	9W	100-265V	1170 Lm	≥0.9	G13	600mm	Milky
T8 Tube Lamp 1200mm - 18W	18W	100-265V	2340 Lm	≥0.9	G13	1200mm	Milky

## Features & Benefits

Category	Indoor Lighting
Sub-Category	Tube Lamps
Type	T8
Variants	Economic & GAEB Standard
Warranty	3 Years

## Certificates

Proudly Made In Egypt,  
General Authority for  
Educational Buildings  
(GAEB) Approval

## T8 Technical Data

Tube Material	PC NANO
E CAP	PC
Color Tempertaure	6400K
Frequency	50Hz
Current	<100mA
Luminous Efficiency	130Lm/W
CRI	≥80
Lifetime	50,000h
Life Code	L80 F50
Complies with	ES7823, ES7773, ES7774, IEC62560, IEC62612



High Luminous  
Intensity



GAEB  
Approved

# OUTDOOR LIGHTING - LED Profile - Strip

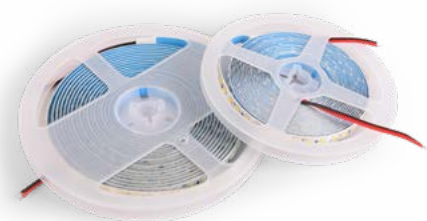

- Cool
- White
- Warm

## Dimensions

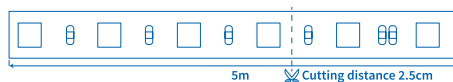

## Models

Models	Power	Voltage Range	Flux	Length	Chips/M	Cutting Distance
LED Strip 12V 240C	10W/M	12V	1100 LM/M	5M	240	25mm
LED Strip 12V 120C	10W/M	12V	1100 LM/M	5M	120	25mm
LED Strip 24V 240C	20W/M	24V	2200 LM/M	5M	240	25mm

## Features & Benefits

Category	Indoor Lighting
Sub-Category	LED Profile
Type	LED Strip
Variants	Cool, White, Warm, 120Chip, 240Chip
Warranty	3 Years

## LED Strip Technical Data

Color Tempertaure	3000K /4000K/ 6400K
Frequency	50Hz
Current	<60mA
Luminous Efficiency	110Lm/W
CRI	≥80
Lifetime	50,000h
Life Code	L80 F50





# INDOOR LIGHTING - LED Profile - Aluminium Rod



## Dimensions

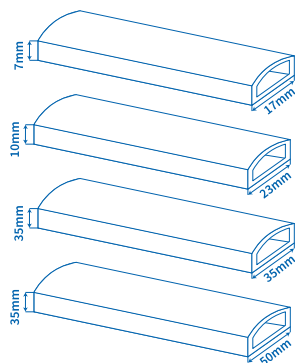

## Models

Models	Length	Dimensions	Color
Aluminum Profile Rod 7 x 17mm	3M	7 x 17mm	Silver
Aluminum Profile Rod 10 x 23mm	3M	10 x 23 mm	Silver
Aluminum Profile Rod 35 x 35mm	2M/3M	35 x 35 mm	Silver, Black, White
Aluminum Profile Rod 35 x 50mm	2M/3M	35 x 50 mm	Silver, Black, White

## Features & Benefits

Category	Indoor Lighting
Sub-Category	LED Profile
Type	Aluminum Rod
Variants	Surface, Recessed, White, Silver, Black

## Aluminum Rod Technical Data

Material	Aluminum
----------	----------



# INDOOR LIGHTING - Recessed Round Compact Panel



## Dimensions

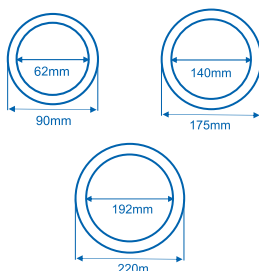

## Features & Benefits

Category	Indoor Lighting
Sub-Category	Compact Panel
Type	Recessed Round
Variants	White, Warm, 1-Color, 3-Colors
Warranty	3 Years
Certificates	Proudly Made In Egypt

## Recessed Round Compact Panels Technical Data

Bulb Material	PC
Housing Material	PC
Color Tempertaure	3000K / 6400K
Frequency	50Hz
Current	<100mA
Luminous Efficiency	100Lm/W
CRI	≥80
Lifetime	25,000h
Life Code	L80 F50
Complies with	ES7823, ES7773, ES7774, IEC62560, IEC62612

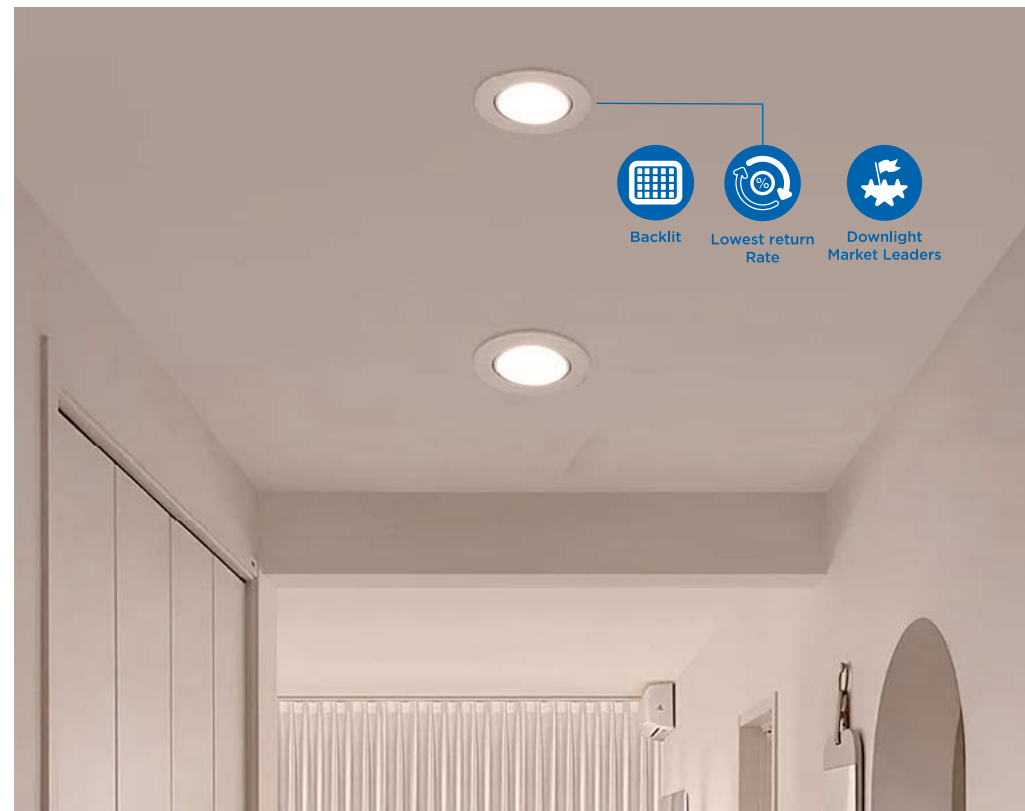

## Models

Models	Power	Voltage Range	Flux	Power Factor (PF)	Outer Dms	Inner Dms	Variants	Outer Color
Recessed Round Compact Panel - 5W	5W	170-250V	400Lm	≥0.5	85mm	64mm	1-Color	Milky
Recessed Round Compact Panel 3 Colors - 5W	5W	170-250V	400Lm	≥0.5	90mm	69mm	3-Color 3000K, 4000K, 6400K	Milky
Recessed Round Compact Panel 3 Colors - 5W	5W	170-250V		≥0.5			3-Color Red, Purple, Blue	Milky
Recessed Round Compact Panel - 15W	15W	170-250V	1500Lm	≥0.5	175mm	140mm	1-Color	Milky
Recessed Round Compact Panel - 18W	18W	170-250V	1800Lm	≥0.5	220mm	192mm	1-Color	Milky
Recessed Round Compact Panel - 24W	24W	170-250V	2400Lm	≥0.5	220mm	192mm	1-Color	Milky

# INDOOR LIGHTING - Recessed Square Compact Panel

## Dimensions



White



Warm

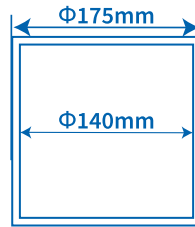

## Models

Models	Power	Voltage Range	Flux	Power Factor (PF)	Outer Dms	Inner Dms	Outer Color
Recessed Square Compact Panel - 15W	15W	175-250V	1500Lm	≥0.5	175mm	140mm	Milky

## Features & Benefits

Category	Indoor Lighting
Sub-Category	Compact Panel
Type	Recessed Square
Variants	White, Warm
Warranty	3 Years
Certificates	Proudly Made In Egypt

## Recessed Square Compact Panels Technical Data

Bulb Material	PC
Housing Material	PC
Color Tempertaure	3000K / 6400K
Frequency	50Hz
Current	<100mA
Luminous Efficiency	100Lm/W
CRI	≥80
Lifetime	25,000h
Life Code	L80 F50
Complies with	ES7823, ES7773, ES7774, IEC62560, IEC62612

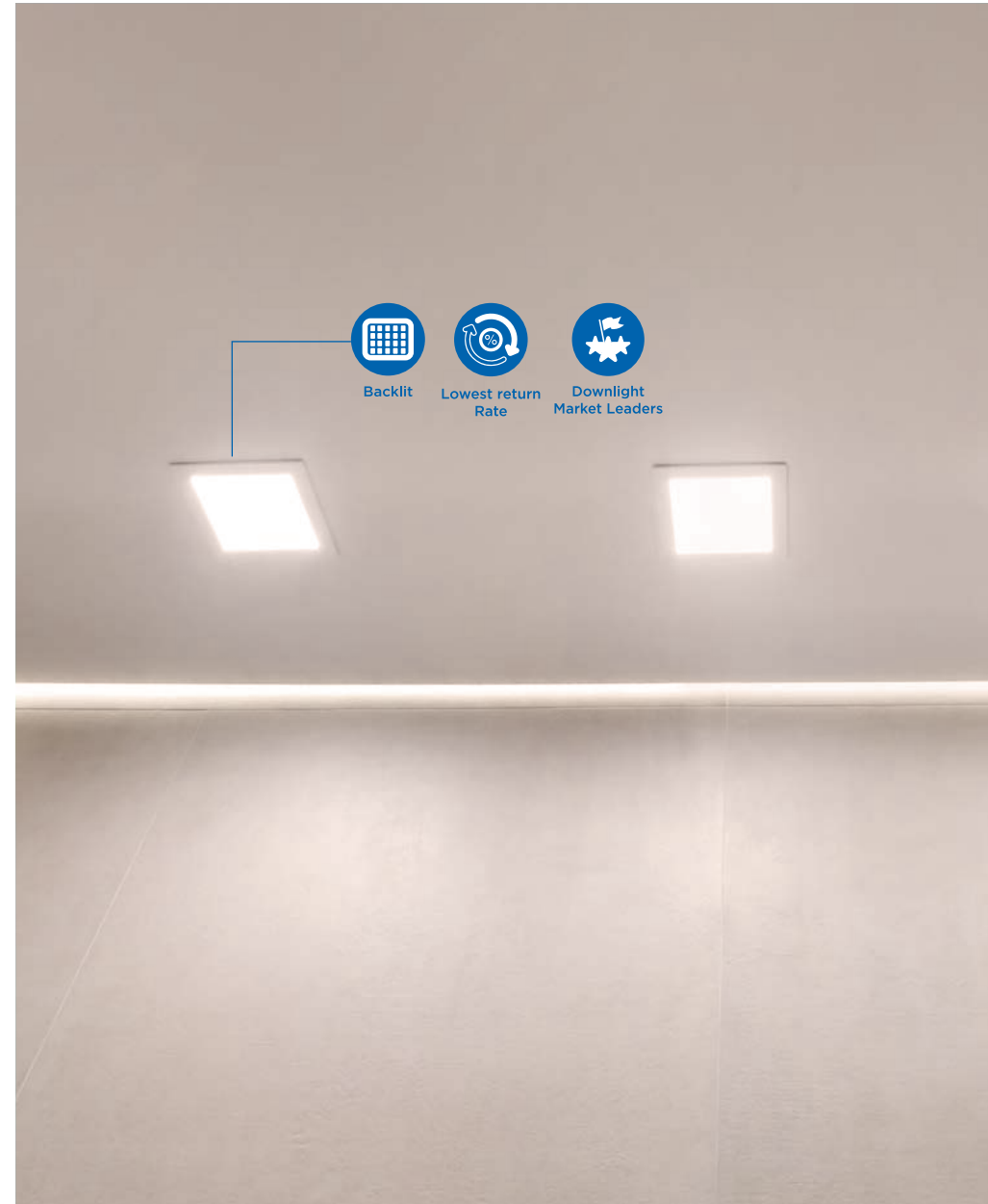



# INDOOR LIGHTING - Surface Round Compact Panel

## Dimensions



White



Warm

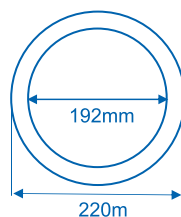

## Models

Models	Power	Voltage Range	Flux	Power Factor (PF)	Outer Dms	Inner Dms	Variants	Outer Color
Surface Round Compact Panel - 18W	18W	175-250V	1800Lm	≥0.5	220mm	192mm	1-Color	Milky
Surface Round Compact Panel - 24W	24W	175-250V	2400Lm	≥0.5	220mm	192mm	1-Color	Milky

## Features & Benefits

Category	Indoor Lighting
Sub-Category	Compact Panel
Type	Surface Round
Variants	White, Warm
Warranty	3 Years
Certificates	Proudly Made In Egypt

## Surface Round Compact Panels Technical Data

Bulb Material	PC
Housing Material	PC
Color Tempertaure	3000K / 6400K
Frequency	50Hz
Current	<100mA
Luminous Efficiency	100Lm/W
CRI	≥80
Lifetime	25,000h
Life Code	L80 F50
Complies with	ES7823, ES7773, ES7774, IEC62560, IEC62612

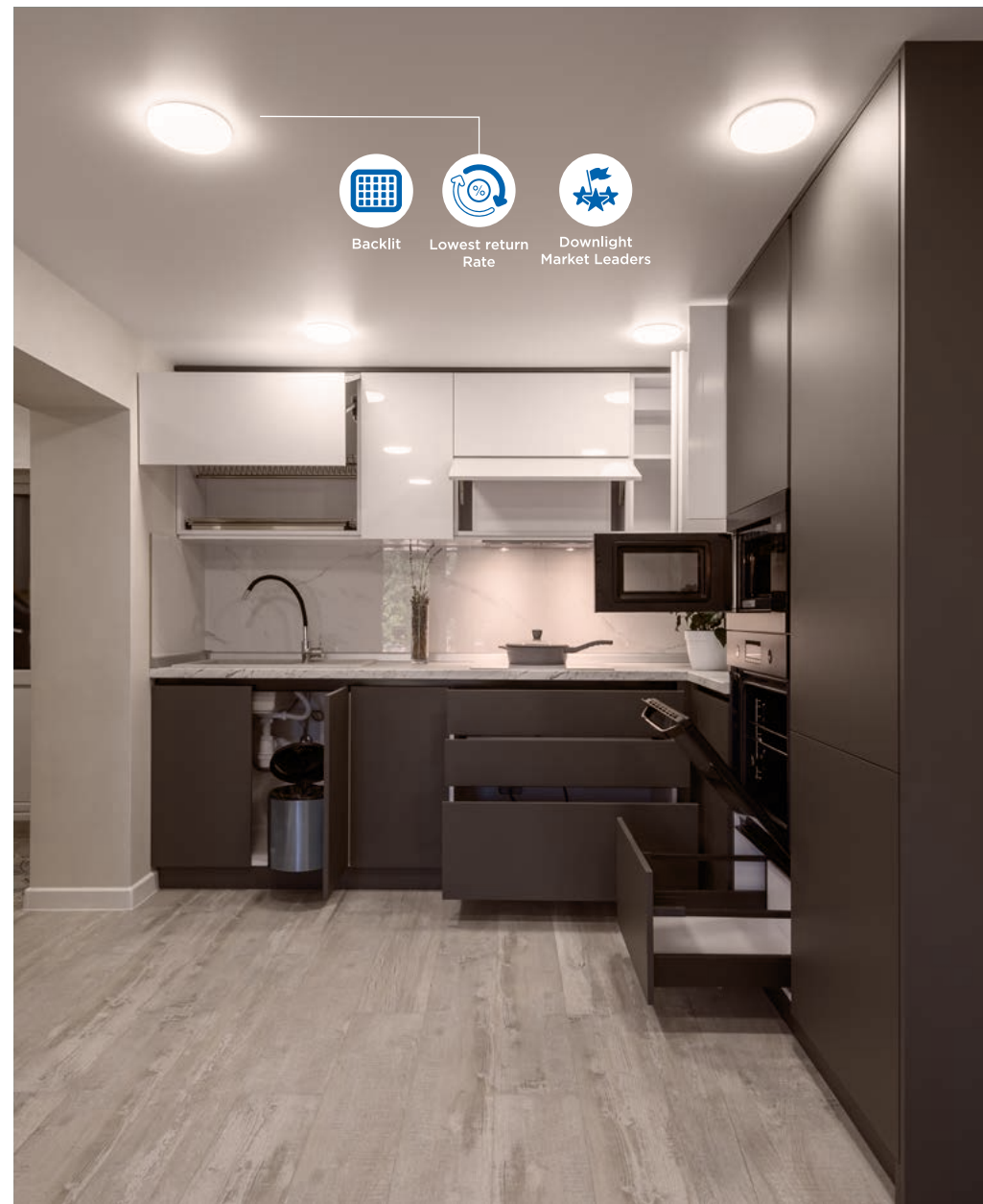

# INDOOR LIGHTING - High Power Surface Ceiling Light

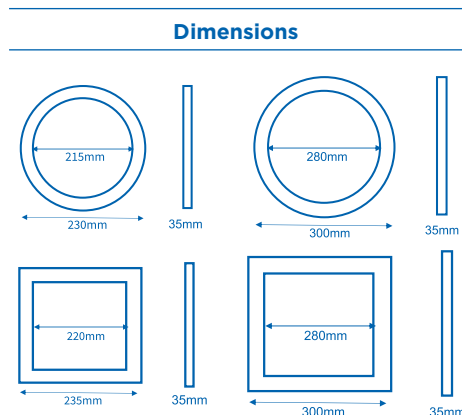

Features & Benefits	
Category	Indoor Lighting
Sub-Category	Ceiling Light
Type	High Power Surface
Variants	White, Warm, Round, Square
Warranty	3 Years
Certificates	Proudly Made In Egypt

High Power Surface Technical Data	
Bulb Material	PC
Housing Material	PC
Color Tempertaure	3000K / 6400K
Frequency	50Hz
Current	<100mA
Luminous Efficiency	100Lm/W
CRI	≥80
Lifetime	25,000h
Life Code	L80 F50
Complies with	ES7823, ES7773, ES7774, IEC62560, IEC62612



Models							
Models	Power	Voltage Range	Flux	Power Factor (PF)	Outer Dms	Inner Dms	Outer Color
Surface Round Ceiling Lights - 36W	36W	175-250V	3600 Lm	≥0.5	230mm	215mm	Milky
Surface Square Ceiling Lights - 36W	36W	175-250V	3600 Lm	≥0.5	235mm	220mm	Milky
Surface Round Ceiling Lights - 48W	48W	175-250V	4800 Lm	≥0.5	300mm	280mm	Milky
Surface Square Ceiling Lights - 48W	48W	175-250V	4800 Lm	≥0.5	300mm	280mm	Milky

# INDOOR LIGHTING - 600x600mm Fixtures Ceiling Light



Economic  
GAEB Specs

## Dimensions

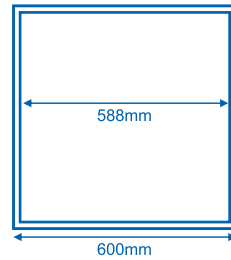

## Models

Models	Power	Voltage Range	Flux	Power Factor (PF)	Outer Dms	Inner Dms	Outer Color
600x600mm Fixture - 48W	48W	100-265V	4800Lm	≥0.9	600mm	588mm	Milky

## Features & Benefits

Category	Indoor Lighting
Sub-Category	Ceiling Light
Type	Surface Square
Variants	Economic & GAEB Standard
Warranty	3 Years
Certificates	Proudly Made In Egypt General Authority for Educational Buildings

## Fixtures Ceiling Light Technical Data

Bulb Material	PC
Housing Material	PC
Color Tempertaure	3000K / 6400K
Frequency	50Hz
Current	<100mA
Luminous Efficiency	100Lm/W
CRI	≥80
Lifetime	50,000h
Life Code	L80 F50
Complies with	ES7823, ES7773, ES7774, IEC62560, IEC62612



Backlit



Downlight  
Market Leaders



GAEB  
Approved



# TYPE INDOOR / OUTDOOR LIGHTING - HP T-Type

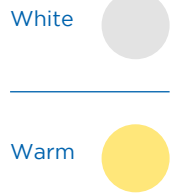

## Dimensions

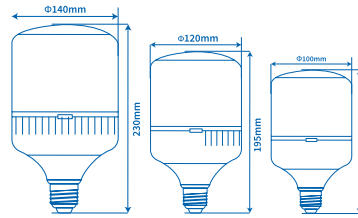

## Models

Models	Power	Voltage Range	Flux	Power Factor (PF)	Cap	Outer Color
T100 Lamp - 30W	30W	175-260V	3300 Lm	≥0.9	E27	Milky
T120 Lamp - 40W	40W	175-260V	4400 Lm	≥0.9	E27/E40	Milky
T140 Lamp - 50W	50W	175-260V	5500 Lm	≥0.9	E27/E40	Milky

## Features & Benefits

Category	Indoor Lighting
Sub-Category	High Power Lamps
Type	T-Type
Variants	Customizable Designs according to Specs, Over Voltage Protection Option
Warranty	3 Years
Certificates	Proudly Made In Egypt

## T-Type Technical Data

Bulb Material	PC
Housing Material	PC
Color Tempertaure	3000K / 6400K
Frequency	50Hz
Current	<100mA
Luminous Efficiency	110Lm/W
CRI	≥80
Lifetime	25,000h
Life Code	L80 F50
Complies with	ES7823, ES7773, ES7774, IEC62560, IEC62612

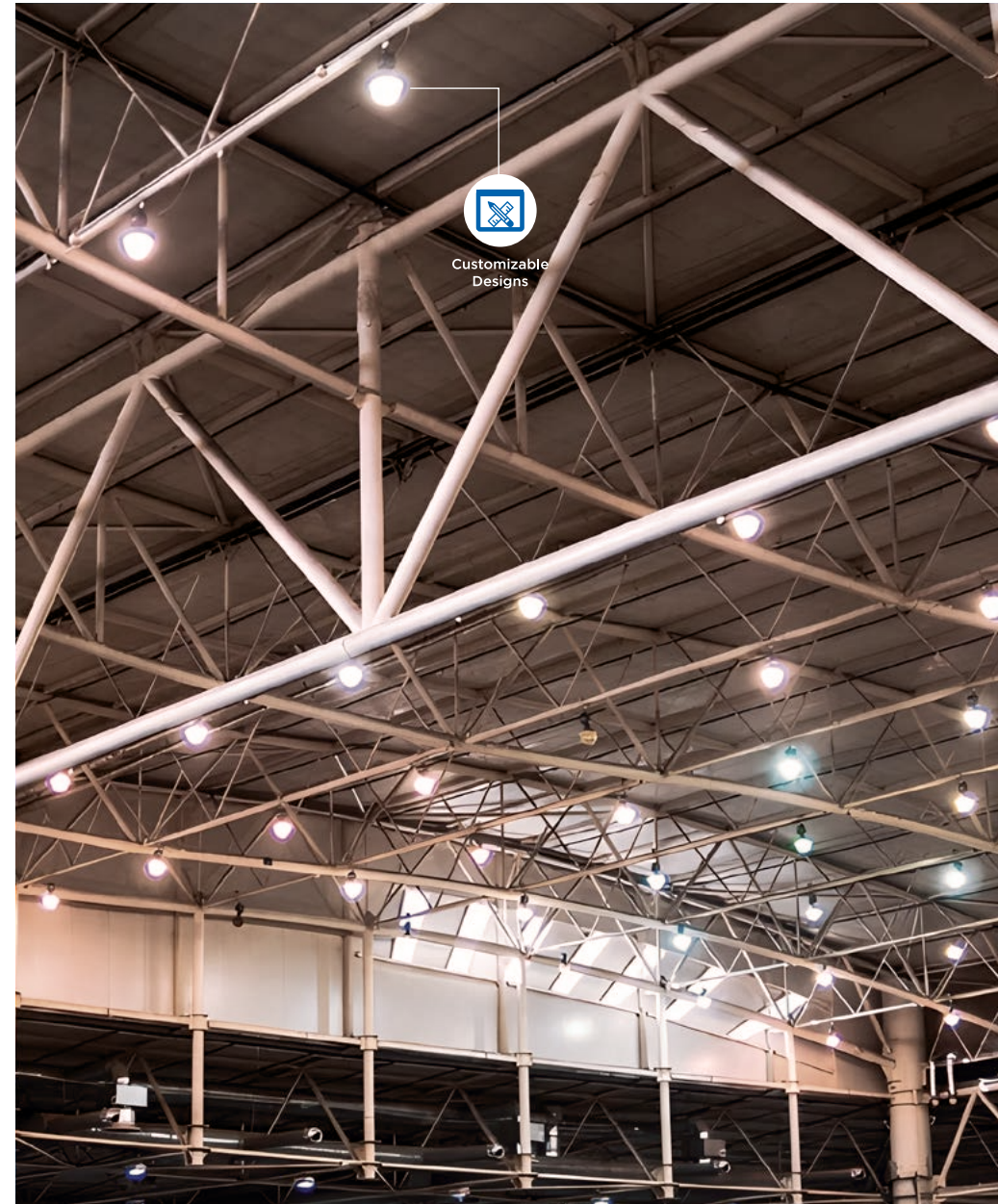

# TYPE INDOOR / OUTDOOR LIGHTING - HP Corn



White



Warm



## Dimensions

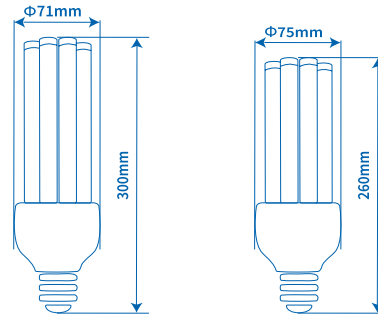

## Models

Models	Power	Voltage Range	Flux	Power Factor (PF)	Cap	Outer Color
Corn Lamp - 30W	30W	100-260V	3300 Lm	≥0.9	E27/E40	Milky
Corn Lamp - 40W	40W	100-260V	4400 Lm	≥0.9	E27/E40	Milky
Corn Lamp - 50W	50W	100-260V	5500 Lm	≥0.9	E27/E40	Milky

## Features & Benefits

Category	Indoor Lighting
Sub-Category	High Power Lamps
Type	Corn
Variants	Customizable Designs according to Specs, Over Voltage Protection Option
Warranty	3 Years
Certificates	Proudly Made In Egypt

## Corn Technical Data

Bulb Material	PC
Housing Material	PC
Color Tempertaure	3000K / 4000K / 6400K
Frequency	50Hz
Current	<100mA
Luminous Efficiency	110Lm/W
CRI	≥80
Lifetime	30,000h
Life Code	L80 F50
Complies with	ES7823, ES7773, ES7774, IEC62560, IEC62612

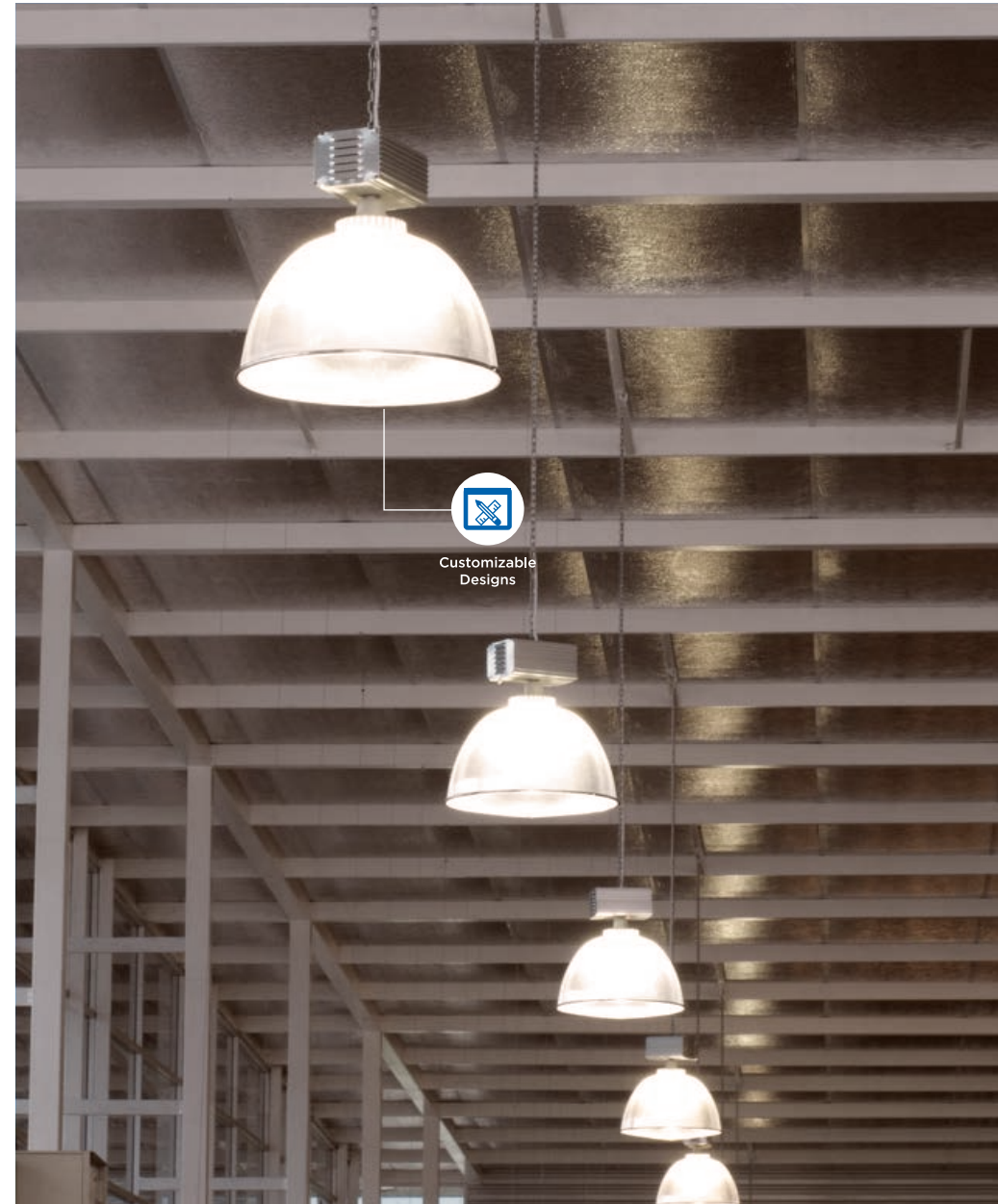

# OUTDOOR LIGHTING - LED Profile - Strip

## Dimensions

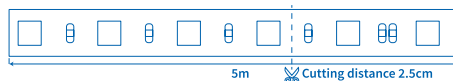

Warm

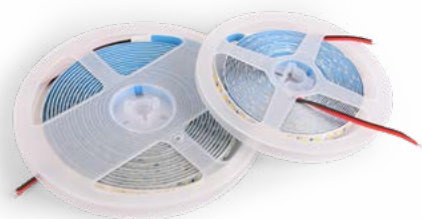

## Models

Models	Power	Voltage Range	Flux	Length	Chips/M	Cutting Distance	Ingress Protection (IP Rating)
LED Strip 24V 240C	20W/M	24V	2200 LM/M	5M	240	25mm	67

## Features & Benefits

Category	Outdoor Lighting
Sub-Category	LED Profile
Type	LED Strip
Variants	Warm

## LED Strip Technical Data

Color Tempertaure	3000K
Frequency	50Hz
Current	<60mA
Luminous Efficiency	110Lm/W
CRI	≥80
Lifetime	50,000h
Life Code	L80 F50





# OUTDOOR LIGHTING - WM Fixtures - Classic



White



Black



## Dimensions

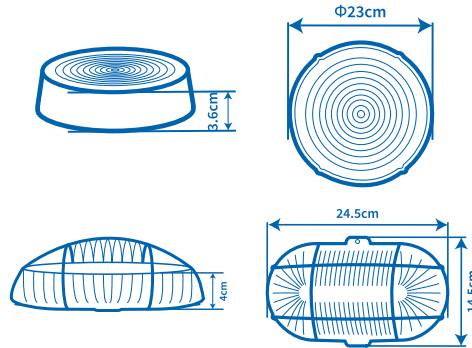

## Models

Models	Installation	Outer Color	Ingress Protection (IP Rating)
Classic Round Wall-Mounted Fixture	Ceiling	Black/White	54
Classic Rectangular Wall-Mounted Fixture	Wall-Mounted	Black/White	54

## Features & Benefits

Category	Outdoor Lighting
Sub-Category	Wall Mounted
Type	WM Classic
Variants	Rectangular, Round, Black, White
Warranty	Lifetime
Certificates	Proudly Made In Egypt

## WM Classic Technical Data

Cover Material	Acrylic
Housing Material	PC
Complies with	IEC60529 IEC62722 IEC 60589

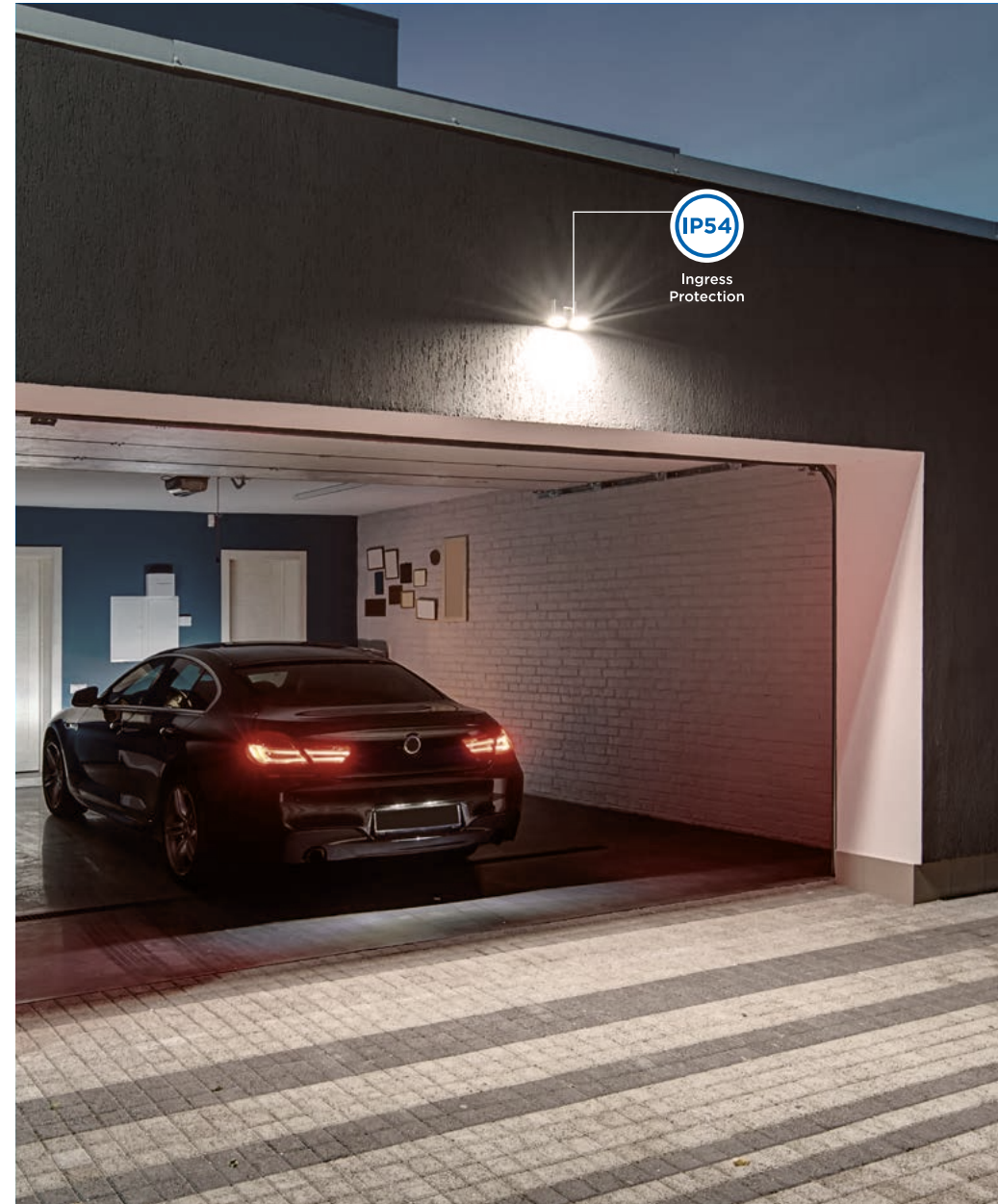

# OUTDOOR LIGHTING - Floodlights



White



Black



### Dimensions

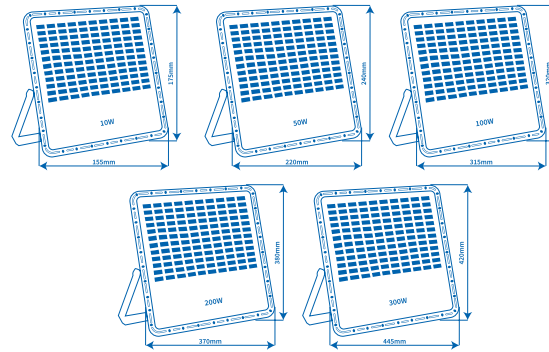

### Features & Benefits

Category	Outdoor Lighting
Sub-Category	Floodlights
Type	FL Elite
Variants	White, Warm
Warranty	3 Years
Certificates	Proudly Made In Egypt General Authority for Educational Buildings (GAEB)

### FL Elite Technical Data

Cover Material	Acrylic
Housing Material	Aluminum
Color Tempertaure	3000K / 6400K
Frequency	50Hz
Current	1500mA
Luminous Efficacy	100Lm/W
CRI	≥80
Lifetime	50,000h
Beam Angle	60° -90°
Life Code	L80 F50
Complies with	IEC60529 IEC62722 IEC 60589



### Models

Models	Power	Voltage Range	Flux	Power Factor (PF)	Ingress Protection (IP Rating)	Impact Resistance (IK Rating)	Outer Color
Floodlight Fixture Elite - 10W	10W	100 - 265V	1000 Lm	≥0.5	67	8	White, Black
Floodlight Fixture Elite - 50W	50W	100 - 265V	5000 Lm	≥0.9	67	8	White, Black
Floodlight Fixture Elite - 100W	100W	100 - 265V	10000 Lm	≥0.9	67	8	White, Black
Floodlight Fixture Elite - 200W	200W	100 - 265V	20000 Lm	≥0.9	67	8	White, Black
Floodlight Fixture Elite - 300W	300W	100 - 265V	30000 Lm	≥0.9	67	8	White, Black

# OUTDOOR LIGHTING - Street Lighting - Spark



- Cool
- White
- Warm

## Dimensions

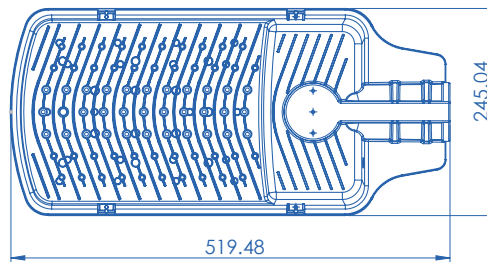

## Features & Benefits

Category	Outdoor Lighting
Sub-Category	Street Lighting
Type	SL Economic
Variants	Narrow Beam Angle, Wide Beam Angle
Warranty	3 Years
Certificates	Proudly Made In Egypt Egyptian Electricity Holding Company Approved

## SL Economic Technical Data

Cover Material	Glass
Housing Material	Aluminum
Color Tempertaure	3000K / 4000 / 6400K
Frequency	50Hz
Current	1000mA
Luminous Efficacy	120Lm/W
CRI	≥80
Lifetime	50,000h
Beam Angle	120°
Life Code	L80 F50
Complies with	IEC60529 IEC62722 IEC 60589

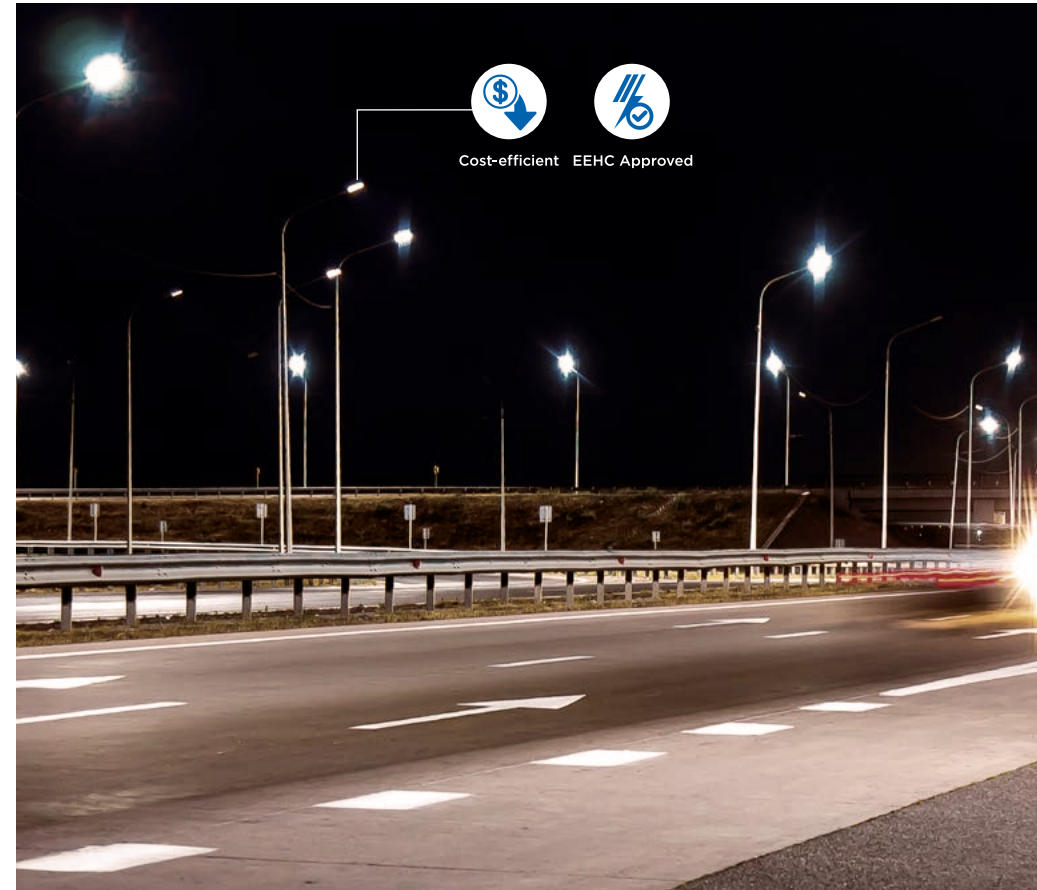

   
Cost-efficient EEHC Approved

## Models

Models	Power	Voltage Range	Flux	Power Factor (PF)	Ingress Protection (IP Rating)	Impact Resistance (IK Rating)	Outer Color
Street Lighting Fixture Economic - 100W	100W	85 - 265V	12000 Lm	≥0.9	66	8	Grey
Street Lighting Fixture Economic - 150W	150W	85 - 265V	18000 Lm	≥0.9	66	8	Grey



# OUTDOOR LIGHTING - Street Lighting - Bright



- Cool
- White
- Warm

## Dimensions

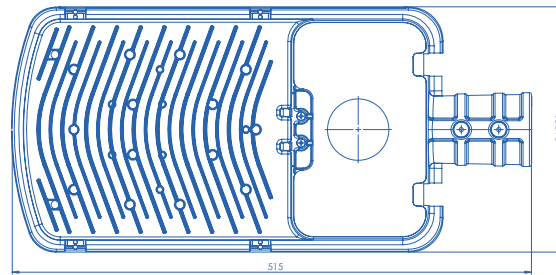

## Features & Benefits

Category	Outdoor Lighting
Sub-Category	Street Lighting
Type	SL Pro
Variants	Narrow Beam Angle, Wide Beam Angle
Warranty	3 Years
Certificates	Proudly Made In Egypt Egyptian Electricity Holding Company Approved

## SL Pro Technical Data

Cover Material	Glass
Housing Material	Aluminum Die-cast
Color Tempertaure	3000K / 4000 / 6400K
Frequency	50Hz
Current	1000 mA
Luminous Efficacy	120 Lm/W
CRI	≥80
Lifetime	50,000h
Beam Angle	120°
Life Code	L80 F50
Complies with	IEC60529 IEC62722 IEC 60589



## Models

Models	Power	Voltage Range	Flux	Power Factor (PF)	Ingress Protection (IP Rating)	Impact Resistance (IK Rating)	Outer Color
Street Lighting Fixture Pro - 100W	100W	85 - 265V	12000 Lm	≥0.9	66	8	Grey
Street Lighting Fixture Pro - 150W	150W	85 - 265V	18000 Lm	≥0.9	66	8	Grey

# CONTACT US

## EGY:

9B, Third Industrial Zone, Badr  
City - Cairo, Egypt

Tel: 02-28606020

Fax: 02-28606151

## RWA:

KN 2 Ave Gakinjiro, Nyarugenge,  
The depot Center - Kigali, Rwanda

Tel: (+250) 734390650

WhatsApp: (+2) 01207542002

 /unistar

 /unistar

 /unistar\_lighting

 [www.unistar-eg.com](http://www.unistar-eg.com)